

CMPB/CMPT (2) – příslušenství**Příslušenství****Tabulka doporučeného příslušenství, sání:**

Typ	sání Ø [mm]	pružná spojka	kruhá klapka	tlumič hluku	ochranná mřížka	kryt motoru
CMPB/CMPT 14	125	MFP-125-N	CARP-125-N	SILP-125	DEF.CIR 12	CMP-14
CMPB/CMPT 20A	160	MFP-160-N	CARP-160-N	SILP-160	DEF.CIR 16	CMP-20
CMPB/CMPT 25A	160	MFP-160-N	CARP-160-N	SILP-160	DEF.CIR 16	CMP-25
CMPB/CMPT 30A	200	MFP-200-N	CARP-200-N	SILP-200	DEF.CIR 20	CMP-30
CMPB/CMPT 20	200	MFP-200-N	CARP-200-N	SILP-200	DEF.CIR 20	CMP-20
CMPB/CMPT 23	250	MFP-250-N	CARP-250-N	SILP-250	DEF.CIR 25	CMP-25
CMPB/CMPT 24	250	MFP-250-N	CARP-250-N	SILP-250	DEF.CIR 25	CMP-25
CMPB/CMPT 25	250	MFP-250-N	CARP-250-N	SILP-250	DEF.CIR 25	CMP-25
CMPB/CMPT 25M	250	MFP-250-N	CARP-250-N	SILP-250	DEF.CIR 25	CMP-25
CMPB/CMPT 30	315	MFP-315-N	CARP-315-N	SILP-315	DEF.CIR 30	CMP-30
CMPB/CMPT 35	355	MFP-355-N	CARP-355-N	SILP-355	DEF.CIR 35	CMP-35
CMPT 42	400	MFP-400-N	CARP-400-N	SILP-400	DEF.CIR 40	CMP-42
CMPT 50	500	MFP-500-N	–	SILP-500	DEF.CIR 50	CMP-50
CMPT 60	600	MFP-600-N	–	–	DEF.CIR 60	CMP-60
CMPT 70	700	MFP-700-N	–	–	DEF.CIR 70	CMP-70

Tabulka doporučeného příslušenství, výtlak:

Typ	výtlak [mm]	přechod na kruhové potrubí	kruhový výfukový kus	čtyřhranný výfukový kus	protidešťová stříška	kruhová klapka	tlumič hluku
CMPB/CMPT 14	Ø 125	–	APP-125-N	–	CTP-125-N	CARP-125-N	SILP-125
CMPB/CMPT 20A	105x90	ACP-20A-N	–	APR-20A	CTP-160-N (+ ACP-20A-N)	CARP-160-N (+ ACP-20A-N)	SILP-160 (+ ACP-20A-N)
CMPB/CMPT 25A	130x115	ACP-25A-N	–	APR-25A	CTP-160-N (+ ACP-25A-N)	CARP-160-N (+ ACP-25A-N)	SILP-160 (+ ACP-25A-N)
CMPB/CMPT 30A	155x140	ACP-30A-N	–	APR-30A	CTP-200-N (+ ACP-30A-N)	CARP-200-N (+ ACP-30A-N)	SILP-200 (+ ACP-30A-N)
CMPB/CMPT 20	Ø 200	–	APP-200-N	–	CTP-200-N	CARP-200-N	SILP-200
CMPB/CMPT 23	Ø 200	–	APP-200-N	–	CTP-200-N	CARP-200-N	SILP-200
CMPB/CMPT 24	Ø 250	–	APP-250-N	–	CTP-250-N	CARP-250-N	SILP-250
CMPB/CMPT 25	Ø 250	–	APP-250-N	–	CTP-250-N	CARP-250-N	SILP-250
CMPB/CMPT 25M	Ø 200	–	APP-200-N	–	CTP-200-N	CARP-200-N	SILP-200
CMPB/CMPT 30	Ø 250	–	APP-250-N	–	CTP-250-N	CARP-250-N	SILP-250
CMPB/CMPT 35	280x225	ACP-35-N	–	APR-35	CTP-400-N (+REP-400/355 + ACP-35-N)	CARP-400-N (+REP-400/355 + ACP-35-N)	SILP-355 (+ ACP-35-N)
CMPT 42	335x270	ACP-42-N	–	APR-42	CTP-400-N (+ ACP-42-N)	CARP-400-N (+ ACP-42-N)	SILP-400 (+ ACP-42-N)
CMPT 50	400x320	ACP-50-N	–	APR-50	CTP-500-N (+ ACP-50-N)	–	SILP-500 (+ ACP-50-N)
CMPT 60	480x385	ACP-60-N	–	APR-60	–	–	–
CMPT 70	560x450	ACP-70-N	–	APR-70	–	–	–

CMP – kryt motoru

CMP-14 až CMP-42



CMP-50, 60 a 70

CMPB/CMPT (2) – příslušenství

DEF.CIR ochranná mřížka sání

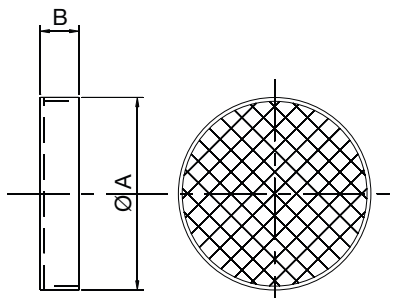

- ochrana proti dotyku a vniknutí cizích těles do ventilátoru
- na sání

Typ	A	B
DEF.CIR 12	125	50
DEF.CIR 16	160	50
DEF.CIR 20	200	50
DEF.CIR 25	250	50
DEF.CIR 30	315	55
DEF.CIR 35	355	80
DEF.CIR 40	400	90
DEF.CIR 50	500	130
DEF.CIR 60	600	130
DEF.CIR 70	700	130

ACP-N přechod na kruhové potrubí

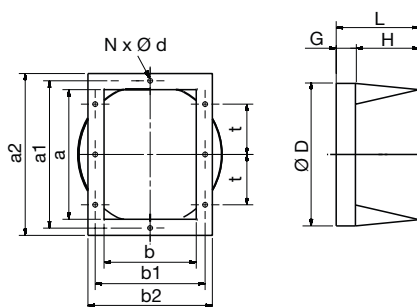

- přechod z čtyřhranného na kruhové potrubí
- včetně uzavírací klapky pro regulaci průtoku
- na výtlač

Typ	a	b	a1	b1	a2	b2	t	N	d	D	G	H	L
ACP-20A-N	105	90	130	120	150	140	90	6	9	160	40	80	120
ACP-25A-N	130	115	160	160	180	180	80	8	7	160	50	70	120
ACP-30A-N	155	140	200	186	221	210	100/93	8	9	200	50	215	265
ACP-35-N	280	225	326	275	356	305	100	12	9	355	60	150	210
ACP-42-N	335	270	381	322	421	362	100	14	9	400	70	160	230
ACP-50-N	400	320	456	386	496	426	100	169	9	500	70	160	230
ACP-60-N	480	385	536	455	586	505	100	16	9	600	70	390	460
ACP-70-N	560	450	616	520	666	570	100	16	11	700	70	390	460

APP-N kruhový výfukový kus

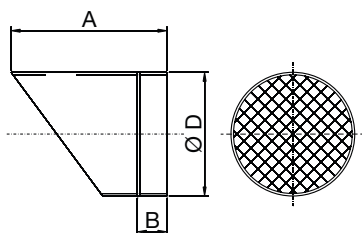
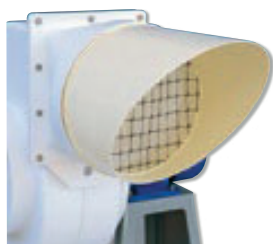

- s ochrannou mřížkou
- na výtlač

Typ	A	B	D
APP-125-N	185	45	125
APP-200-N	280	55	200
APP-250-N	315	60	250

APR čtyřhranný výfukový kus

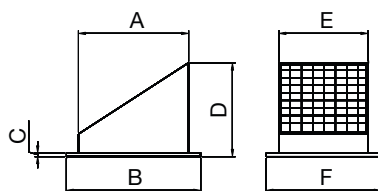

- s ochrannou mřížkou
- včetně uzavírací klapky pro regulaci průtoku
- na výtlač

Typ	A	B	C	D	E	F
APR-20A	110	150	8	130	100	140
APR-25A	135	180	8	150	120	180
APR-30A	165	221	8	170	135	210
APR-35	292	356	10	249	237	305
APR-42	340	421	8	245	280	362
APR-50	410	496	8	285	330	426
APR-60	490	586	8	330	395	505
APR-70	570	666	8	380	460	570

19

CTP-N protidešťová stříška

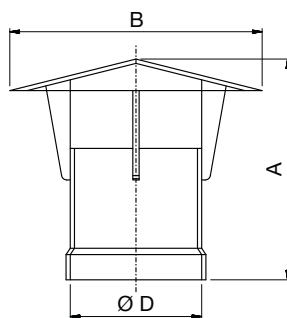

- protidešťová stříška
- na výtlač

Typ	A	B	D
CTP-125-N	300	280	125
CTP-160-N	310	300	160
CTP-200-N	335	400	200
CTP-250-N	420	480	250
CTP-400-N	565	750	400
CTP-500-N	735	980	500

REP 400/355 přechod

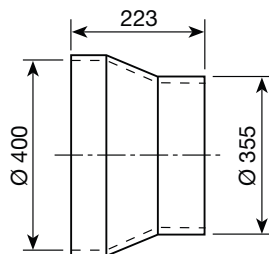

- přechod pro redukci průměru potrubí
- na výtlač

CMPB/CMPT (2) – příslušenství

MFP-N pružná spojka



- pro připojení potrubí k ventilátoru
- na sání

Typ	Ø
MFP-125-N	125
MFP-160-N	160
MFP-200-N	200
MFP-250-N	250
MFP-315-N	315
MFP-355-N	355
MFP-400-N	400
MFP-500-N	500
MFP-600-N	600
MFP-700-N	700

19

CARP-N kruhová klapka

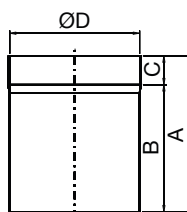

- ručně ovládaná kruhová klapka
- na sání i na výtlač

Typ	A	B	C	D
CARP-125-N	190	150	40	125
CARP-160-N	240	190	50	160
CARP-200-N	240	190	50	200
CARP-250-N	300	250	50	250
CARP-355-N	400	340	60	355
CARP-400-N	450	390	60	400

SILP tlumič hluku

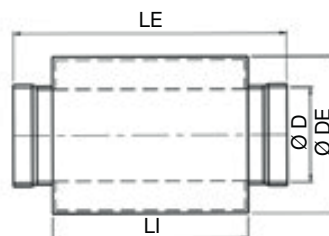

- tlumič hluku
- na sání i na výtlač

Typ	rozměry [mm]				útlum dB(A) ve frekvenčním pásmu [Hz]							
	D	DE	LI	LE	63	125	250	500	1000	2000	4000	8000
SILP-125	125	250	500	700	-	1	4	8	13	12	7	4
SILP-160	160	315	500	700	-	1	4	8	13	12	7	4
SILP-200	200	355	500	700	1	2	5	9	13	12	7	5
SILP-250	250	400	500	700	3	2	6	10	13	12	8	6
SILP-315	315	500	750	950	2	3	7	10	13	12	9	9
SILP-355	355	600	750	950	2	3	8	11	14	11	7	8
SILP-400	400	700	1000	1200	3	3	8	11	14	11	7	7
SILP-500	500	800	1000	1200	2	4	9	12	18	13	7	7